

masalletebain.com

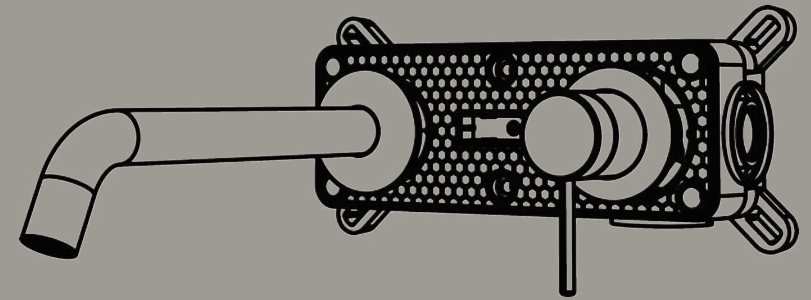

masallobebain.com

Nous vous remercions,

d'avoir choisi les produits masallobebain.com,
et de la confiance que vous nous accordez.

Afin d'assurer une installation optimale,
nous vous invitons à suivre attentivement les instructions
renseignés dans ce document.
Notre équipe est à votre disposition pour toute assistance
complémentaire.

Thank you,

for choosing masallobebain.com products,
and for the trust you have placed in us.
To ensure optimal installation,
we invite you to carefully follow the instructions given in
this document. Our team is available for any further
assistance you may need.

Instructions d'Installation



Schéma du raccordement de l'eau chaude et de l'eau froide



Dimensions de perçage conseillées pour les carreaux

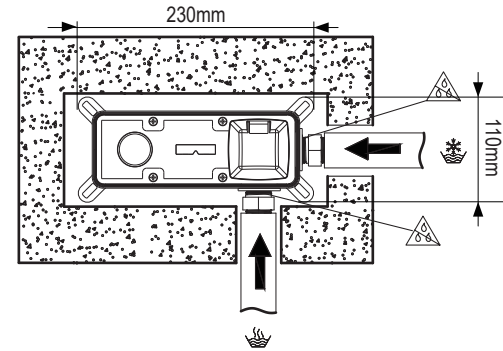
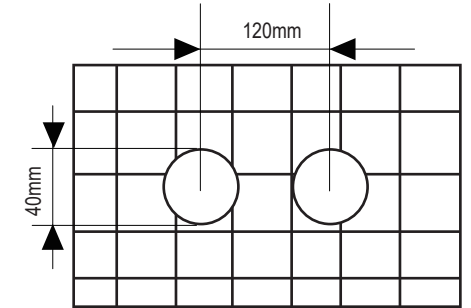
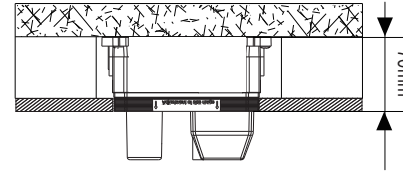

Prévoir une ouverture murale supérieure de
2 à 3 cm par rapport au boîtier d'encastrement.

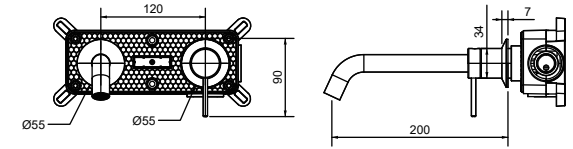

Voir schéma des dimensions

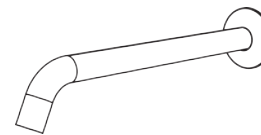

MODELE:VC4006
DIMENSION:250MM

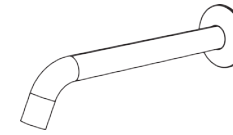

MODELE:VC4007
DIMENSION:200MM

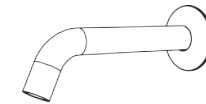

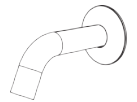

MODELE:VC4008
DIMENSION:150MM



MODELE:VC4009
DIMENSION:100MM

Conseils:

 Veuillez vous assurer qu'il n'y a pas de fuite d'eau
au niveau du raccord entre le tuyau d'eau et le robinet.

 Eau chaude

 Eau froide

